



ISP1763A PCI evaluation board

UM0865

User manual

Abstract

This document describes board level operations of the ISP1763A PCI evaluation board. Two version of the board are available: one for the TFBGA package and the other for the VFQFPN package.

The ISP1763A PCI evaluation board allows engineers and software developers to create USB host, device, and OTG features for customer applications.

Keywords

isp1763a; usb; universal serial bus; host controller; otg; on-the-go

Legal information

© Copyright ST-Ericsson, 2010. All rights reserved.

Disclaimer

The contents of this document are subject to change without prior notice. ST-Ericsson makes no representation or warranty of any nature whatsoever (neither expressed nor implied) with respect to the matters addressed in this document, including but not limited to warranties of merchantability or fitness for a particular purpose, interpretability or interoperability or, against infringement of third party intellectual property rights, and in no event shall ST-Ericsson be liable to any party for any direct, indirect, incidental and or consequential damages and or loss whatsoever (including but not limited to monetary losses or loss of data), that might arise from the use of this document or the information in it.

ST-Ericsson and the ST-Ericsson logo are trademarks of the ST-Ericsson group of companies or used under a license from STMicroelectronics NV or Telefonaktiebolaget LM Ericsson.

All other names are the property of their respective owners.

Trademark list

All trademarks and registered trademarks are the property of their respective owners.

Contents

1	About this document	5
1.1	Purpose	5
1.2	Revision information	5
1.3	Board history	5
1.4	Reference list	5
2	Introduction	6
2.1	Key features	6
2.2	Basic operation	8
2.2.1	Working with Linux OS	8
2.2.2	Working with Windows CE OS	8
3	Physical description	9
3.1	Board layout	9
3.2	Connectors	9
3.2.1	J1 PLX signals probe connector	10
3.2.2	J2 ISP1763A bus interface	10
3.2.3	J3, J4, J5, and J6 bus test headers	11
3.2.4	USB ports	11
3.2.5	JP1 Xilinx 3-state input	11
3.2.6	JP2 Xilinx PROG input	11
3.2.7	JP3 Xilinx JTAG connector	11
3.2.8	JP4 GND connector	12
3.2.9	JP5 GND connector	12
3.2.10	JP6 +5 V power select	12
3.2.11	JP7 $V_{CC(I/O)}$ select	12
3.2.12	PS1 PC power connector	12
3.2.13	PS2 DC power socket	12
3.2.14	CON1 PCI connector	12
3.2.15	CN1 PXA320 platform connector	13
3.2.16	DC1 DM357platform connector	13

3.2.17	Conf1* butterfly configuration	13
3.3	LEDs	14
3.4	Board components	15
3.4.1	ISP1763A chip	15
3.4.2	PLX9054 and 93LC56C EEPROM	16
3.4.3	Xilinx XC3S500E	17
4	Schematics	18
5	List of materials	25
	Glossary	29

1 About this document

1.1 Purpose

This document provides description on how to use the evaluation module to develop software for customers.

1.2 Revision information

Table 1 *Revision history*

Date	Rev.	Comments
2010-02-12	1	First release.
2010-04-05	2	Updated the last paragraph of Section 3.2.3 and Section 3.2.7. Changed the package name from HVQFN to VFQFPN.

1.3 Board history

Table 2 *Board history*

Date	Rev.	Comments
2009-10-30	09283-1	ISP1763 PCI evaluation board (TFBGA) first release.
2009-10-30	09282-1	ISP1763 PCI evaluation board (VFQFPN) first release.

1.4 Reference list

- [1] *Universal Serial Bus Specification Rev. 2.0* www.usb.org
- [2] *PCI Local Bus Specification Version 2.2*
- [3] *PLX PCI 9054 Data Sheet*
- [4] *ISP1763A PCI evaluation board - FPGA design (UM0887)* CD00259895
- [5] *ISP1763A Hi-Speed USB OTG controller data sheet* CD00264885
- [6] *ISP1763A programming guide (PM0070)* CD00265095

2 Introduction

This section provides a description of the ISP1763A PCI evaluation board along with the key features and a block diagram of the circuit board.

2.1 Key features

The ISP1763A is a Hi-Speed Universal Serial Bus (USB) On-The-Go (OTG) dual-role controller with two USB ports. Port 1 is configurable as a host controller, an OTG controller, or a peripheral controller, while port 2 is always assigned to the host controller.

The ISP1763A bus interface provides SRAM, general-multiplex, NOR, and NAND modes to communicate with most types of microcontrollers and microprocessors.

The PCI bridge board allows you to demonstrate the functionality of the ISP1763A on a standard PC with at least one PCI slot.

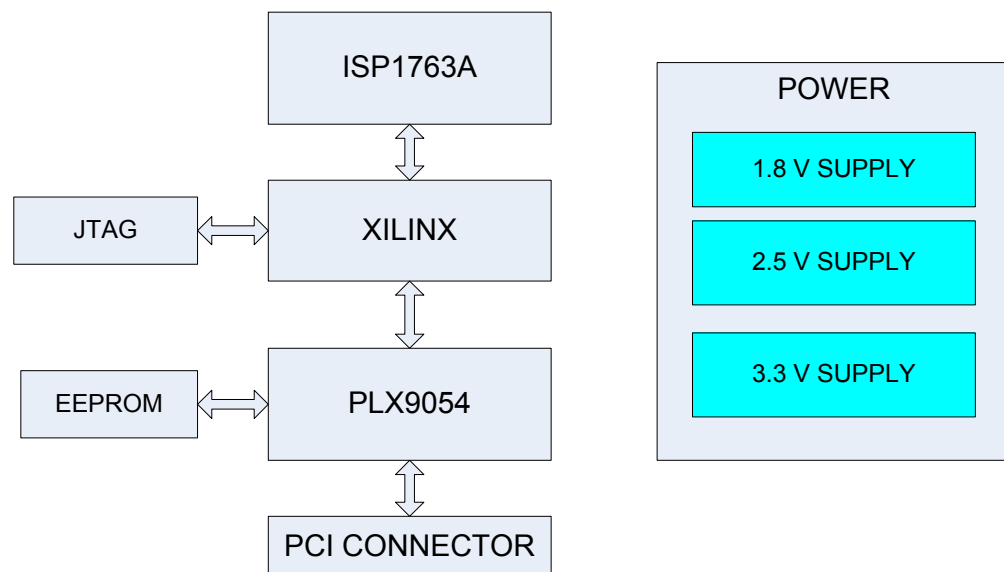

Figure 1 Block diagram of the ISP1763A PCI evaluation board

Key features include:

- 12 MHz crystal clock input
- One OTG port, one host only port
- Four types of bus interfaces
- FPGA configuration
- PCI connection

- Multiple voltage power supply
- All local bus signals are easily accessible on test headers designed for direct connection of a standard Tektronix logic analyzer

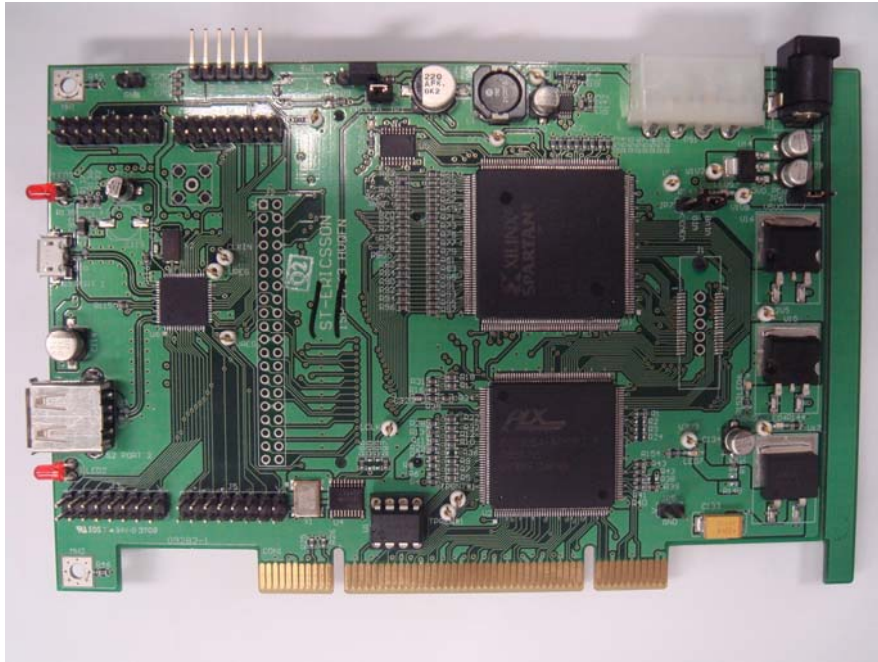

Figure 2 ISP1763A PCI evaluation board—VFQFP

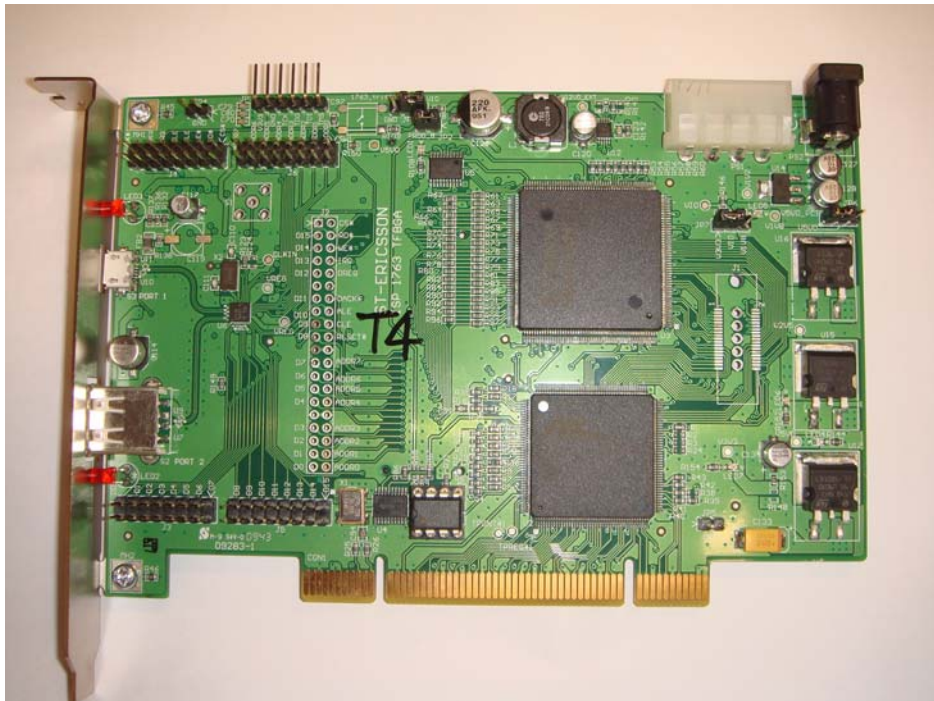

Figure 3 ISP1763A PCI evaluation board—TFBGA

2.2 Basic operation

2.2.1 Working with Linux OS

Any x86-based computer that has a PCI slot (32-bit, 33 MHz) running with Linux Red Hat kernel can be used. The type of Linux Red Hat installation determines minimum system requirements. The minimum recommended system configuration is a Pentium-class processor (1 GHz) with 128 MB RAM.

2.2.2 Working with Windows CE OS

An x86-based computer that has an available PCI slot (32-bit, 33 MHz) running Windows CE ver. 5.0 or ver. 6.0 OS can be used. For ST-Ericsson set-up example, use Gigabyte GA-945GZM-S2 motherboard (on board Ethernet controller disabled) with RealTek PCI Ethernet card (PCI vendor ID is 10ECh and device ID is 8139h), and a standard 1.44 MB floppy disk drive (for system boot up). Follow this hardware configuration as much as possible, especially the motherboard and the Ethernet card.

3 Physical description

This section describes the physical layout of the ISP1763A PCI evaluation board and its interface.

3.1 Board layout

The ISP1763A PCI evaluation board is 150 x 101.6 mm six-layer (TFBGA) or four-layer (VFQFPN) printed-circuit board that is powered by the PCI slot power.

Figure 4 shows the layout of the top view of the ISP1763A PCI evaluation board.

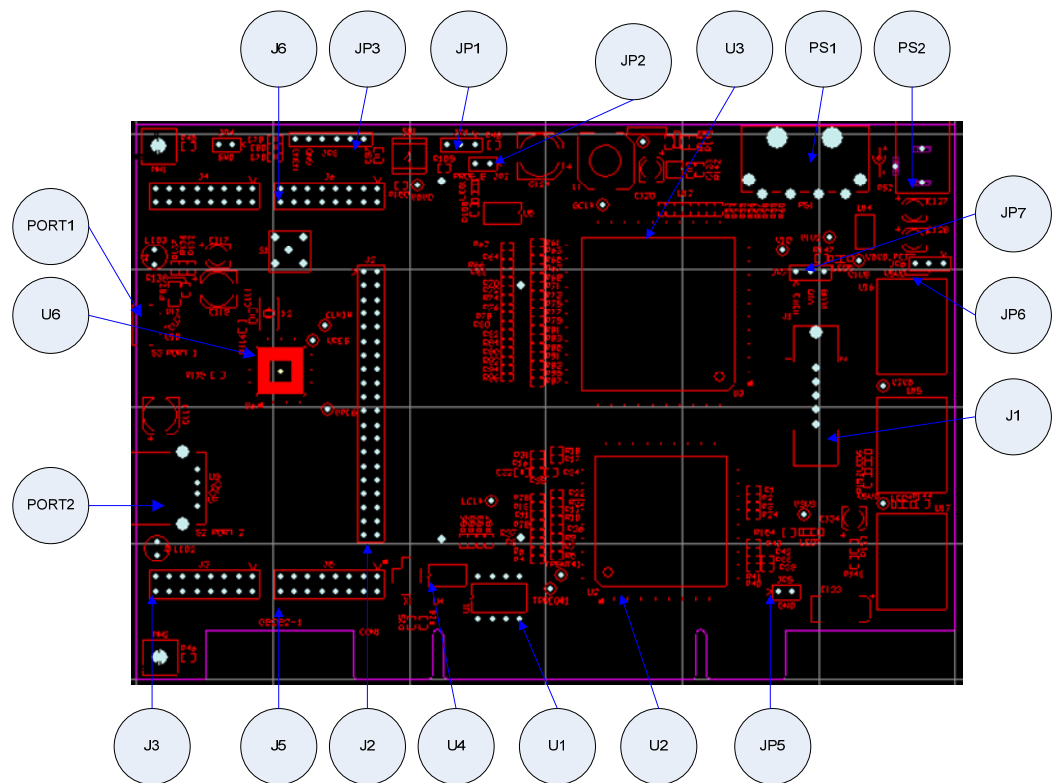

Figure 4 ISP1763A PCI evaluation board - top view

3.2 Connectors

These connectors and jumpers are described in the following sections.

Table 3 Connectors

Connector	Function
J1	PLX signals probe connector 1
J2	ISP1763A bus interface
J3	Bus test header. Lower 8-bit AD bus.
J4	Bus test header. Control signal of the ISP1763A.
J5	Bus test header. Upper 8-bit AD bus.
J6	Bus test header. 8-bit address bus.
S3 / port 1	Micro-AB USB connector.
S2 / port 2	Standard-A USB connector.
JP1	Xilinx Tristate input. Tristate input to Xilinx to 3-state signals to the ISP1763A.
JP2	Xilinx PROG input. When this jumper is connected, the FPGA code will be loaded to Xilinx from U5.
JP3	Xilinx JTAG connector
JP4	GND connector
JP5	GND connector
JP6	+5 V power select
JP7	$V_{CC(I/O)}$ select
PS1	PC power connector
PS2	DC power socket
CON1	PCI connector
CN1	PXA320 platform connector
DC1	DM357 platform connector
Conf1*	Butterfly configuration

3.2.1 J1 PLX signals probe connector

This is only for using the logic analyzer. Probe debug signals between FPGA and PLX9054 communication.

The default setting is not mounted on board.

3.2.2 J2 ISP1763A bus interface

This header has all the address bus, data bus, and control signals of the ISP1763A.

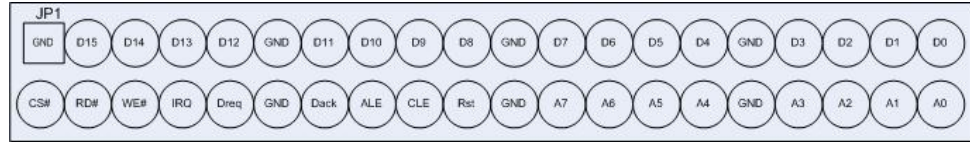

Figure 5 J2 bus interface

3.2.3 J3, J4, J5, and J6 bus test headers

These headers are only used to probe bus interface signals. Only for testing.

The J3 male header is for lower 8-bit AD[7:0] signals.

The J5 male header is for upper 8-bit AD[15:8] signals.

The J4 male header is for the DACK, DREQ, IRQ, CLE, ALE/ADV_N, WR_N/RW_N/WE_N, RD_N/DS_N/RE_N/OE_N, and CS_N/CE_N control signals.

The J6 male header is for 8-bit A[7:0] signals.

3.2.4 USB ports

The ISP1763A has two ports.

- Port 1 can be configured as either the host controller or the peripheral controller. Has a micro-AB USB connector on board.
- Port 2 is configured as the host controller. Has a standard-A USB host connector on board.

3.2.5 JP1 Xilinx 3-state input

This is the 3-state input to Xilinx.

Connect pin 1 and pin 2. The Xilinx pins connected to the ISP1763A are not 3-stated.

Connect pin 3 and pin 2. The Xilinx pins connected to the ISP1763A are 3-stated.

3.2.6 JP2 Xilinx PROG input

This is the Xilinx PROG input. When this jumper is connected, the FPGA code will be loaded to Xilinx from U5.

3.2.7 JP3 Xilinx JTAG connector

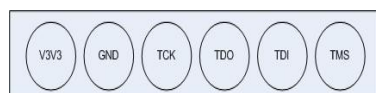

Figure 6 JP3 JTAG connector

Through the JTAG interface, download program into Xilinx XC3S500E.

Use the Xilinx USB blaster to connect the JTAG interface on board. LED1 turns on when FPGA successfully completes configuration.

3.2.8 JP4 GND connector

The GND connector is to connect the oscilloscope or logic analyzer probe.

3.2.9 JP5 GND connector

The GND connector is to connect the oscilloscope or logic analyzer probe.

3.2.10 JP6 +5 V power select

This is the 5 V power supply select.

Connect pin 1 and pin 2. 5 V is supplied by external power supply PS1 or PS2.

Connect pin 2 and pin 3. 5 V is supplied by the PCI slot (default).

3.2.11 JP7 $V_{CC(I/O)}$ select

This is the $V_{CC(I/O)}$ power supply select.

Connect pin 1 and pin 2. $V_{CC(I/O)}$ is powered by 3.3 V (default).

Connect pin 2 and pin 3. $V_{CC(I/O)}$ is powered by 1.8 V.

3.2.12 PS1 PC power connector

Used for external supply of +12 V from the PC power supply. Connect pin 1 and pin 2 of JP6. 5 V is supplied by external power supply PS1.

This is not used when the ISP1763A is inserted into the PCI slot.

3.2.13 PS2 DC power socket

Used for the external supply of +12 V / 3 A from the DC power supply. Connect pin 1 and pin 2 of JP6. 5 V is supplied by external power supply PS2.

This is not used when the ISP1763A is inserted into the PCI slot.

3.2.14 CON1 PCI connector

This is the standard PCI bus interface that is compliant with *PCI Local Bus Specification Ver. 2.2*.

All PCI signals are connected to PLX9054 PCI-to-local bus I/O accelerator chip.

3.2.15 CN1 PXA320 platform connector

By default, this connector is not mounted. Only for the BSQUARE PXA320 platform use.

While using this connector with the PXA320 platform, the ISP1763A PCI evaluation board is powered by external DC +12 V / 3 A power supply PS2.

1. Connect pin 1 and pin 2 of jumper JP6. The evaluation board is powered by the external power supply.
2. Connect pin 1 and pin 2 of jumper JP7. The I/O voltage of the ISP1763A is set at 3.3 V. The PXA320 platform does not provide 1.8 V.
3. Connect pin 2 and pin 3 of jumper JP1. It 3-states all I/O pins from the FPGA connected to the ISP1763A IC.
4. Connect pin 1 and pin 2 of jumper JP2. The FPGA program is loaded from U5. The program has the logic for the 3-state of the pins.

3.2.16 DC1 DM357 platform connector

By default, this connector is not mounted. Only for the DAVINCI DM357 platform use.

While using this connector with the DM357 platform, the ISP1763A PCI evaluation board is powered by external DC +12 V / 3 A power supply PS2.

1. Connect pin 1 and pin 2 of jumper JP6. The evaluation board is powered by the external power supply.
2. Connect pin 2 and pin 3 of jumper JP7. The I/O voltage of the ISP1763A is set at 1.8 V. The DM357 platform does not provide 3.3 V.
3. Connect pin 2 and pin 3 of jumper JP1. It 3-states all I/O pins from the FPGA connected to the ISP1763A IC.
4. Connect pin 1 and pin 2 of jumper JP2. The FPGA program is loaded from U5. The program has the logic for the 3-state of pins.

3.2.17 Conf1* butterfly configuration

Frequency selection is done using pins FREQSEL1 and FREQSEL2. The corresponding resistors are mounted to connect FREQSEL1 and FREQSEL2 to GND or $V_{CC(I/O)}$.

- To connect FREQSEL2 to LOW, mount R111 and remove R113.
- To connect FREQSEL2 to HIGH, mount R113 and remove R111.
- To connect FREQSEL1 to LOW, mount R112 and remove R114.
- To connect FREQSEL1 to HIGH, mount R114 and remove R112.

The PIO mode selection is needed only for the actual platform validation.

On the x86 platform, PIO mode selection is done using the Xilinx FPGA code. The mounting of resistors (R119 to R122) do not affect the mode selection done by Xilinx. To configure in various modes, refer to *ISP1763A PCI evaluation board - FPGA design (UM0887)*.

When the ISP1763A is connected to customer platform, mode selection is done using pins CLE and ALE/ADV_N. The corresponding resistors are mounted to connect CLE and ALE/ADV_N to GND or $V_{CC(I/O)}$.

- To connect CLE to LOW, mount R120 and remove R122.
- To connect CLE to HIGH, mount R122 and remove R120.
- To connect ALE/ADV_N to LOW, mount R119 and remove R121.
- To connect ALE/ADV_N to HIGH, mount R121 and remove R119.

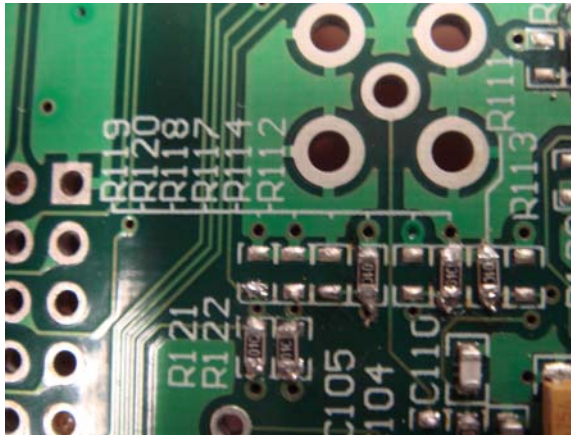

Figure 7 Butterfly configuration

Table 4 Clock frequency and bus interface configuration

Clock frequency	12 MHz (default)	19.2 MHz	24 MHz	Reserved	Comment
FREQSEL2	LOW	LOW	HIGH	HIGH	Through R111 to GND. Through R113 to $V_{CC(I/O)}$.
FREQSEL1	LOW	HIGH	LOW	HIGH	Through R112 to GND. Through R114 to $V_{CC(I/O)}$.
Bus interface	SRAM (default)	NAND	NOR	General multiplex	Comment
CLE	HIGH	LOW	LOW	HIGH	Through R120 to GND. Through R122 to $V_{CC(I/O)}$.
ALE/ADV_N	HIGH	LOW	HIGH	LOW	Through R119 to GND. Through R121 to $V_{CC(I/O)}$.

3.3 LEDs

The ISP1763A PCI evaluation board has seven LEDs that are located on the top side of the board. Information regarding these LEDs is given in Table 5.

Table 5 LED

LED	Use	Color
LED1	JTAG download or program done indicator	Orange
LED2	V _{BUS2} volts indicator (After loading the host software, the light will be turned on.)	Red
LED3	V _{BUS1} volts indicator (After loading the host software, the light will be turned on.)	Red
LED4	+5 V indicator	Blue
LED5	+1.8 V indicator	Red
LED6	+2.5 V indicator	Yellow
LED7	+3.3 V indicator	Green

3.4 Board components

This describes the operation of the major board components on the ISP1763A PCI evaluation board.

3.4.1 ISP1763A chip

The ISP1763A PCI evaluation board is available in two packages: TFBGA and VFQFPN.



Figure 8 ISP1763A VFQFPN



Figure 9 ISP1763A TFBGA

Table 6 ISP1763A chip package information

Product	Package	Package description
ISP1763AETTM	TFBGA64	64 balls; body 4 × 4 × 0.8 mm
ISP1763AHNTM	VFQFPN64	64 terminals; body 9 × 9 × 1.0 mm

For the schematic design, there is no difference, except the chip footprint.

For the PCB layout, TFBGA is six-layered design whereas VFQFPN is only four-layered design. All the components are same on both the boards, except the ISP1763A IC package.

3.4.2 PLX9054 and 93LC56C EEPROM

PLX9054 is a PCI-to-local-bus accelerator. The ISP1763A is always a PCI target during initialization, as well as during the data transfer phase to or from the ISP1763A memory.



Figure 10 PLX9054

When powering on or asserting the PCI_RESET signal, PLX9054 attempts to read the serial EEPROM to check its presence.

The 93LC56C EEPROM is required for the correct initialization of PLX9054. The serial EEPROM contains information required to initialize PLX9054 registers. For details, refer to Chapter 11 of *PLX PCI 9054 Data Sheet*.

The initial programming of 93C56 must be done in a serial EEPROM programmer. Displaying and adjusting of certain parameters can be done using the PLXmon utility.



Figure 11 EEPROM 93C56

3.4.3

Xilinx XC3S500E

FPGA ensures adaptation between the ISP1763A generic bus interface and the PLX9054 local bus interface. The FPGA programming can be downloaded through the JTAG interface.



Figure 12 Xilinx XC3S500E

For detail description of the FPGA programming, refer to *ISP1763A PCI evaluation board - FPGA design (UM0887)*.

4 Schematics

ISP1763A PCI EVALUATION BOARD

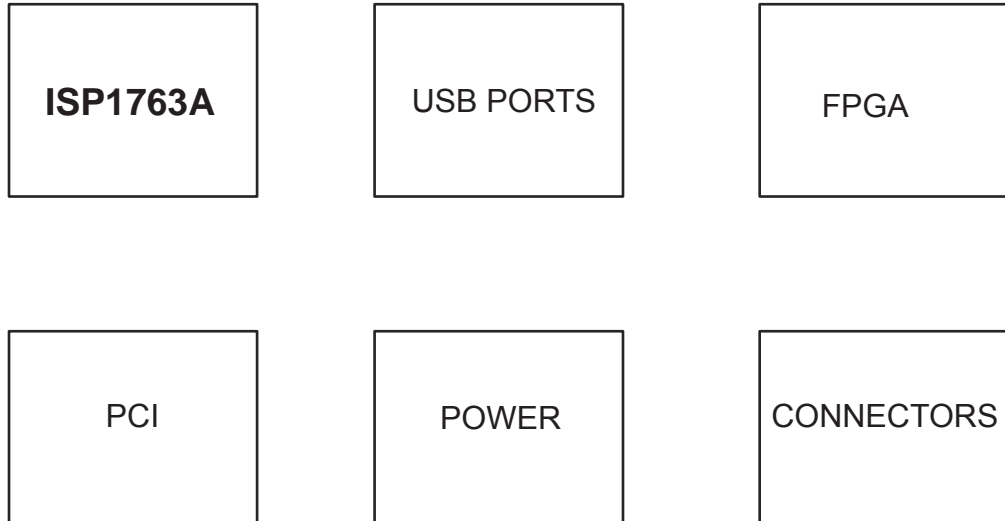

Figure 13 Main

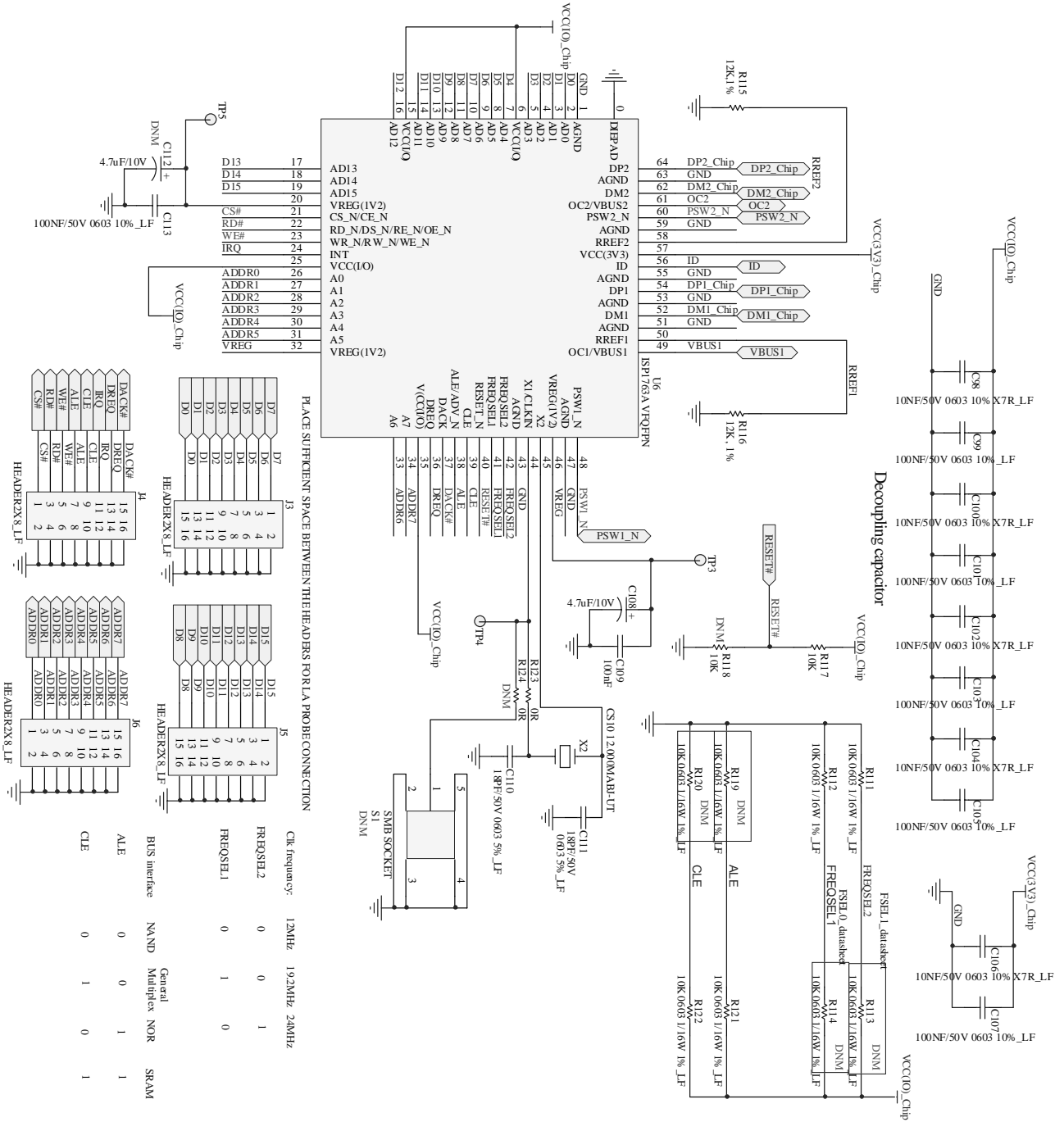

Figure 14 ISP1763A

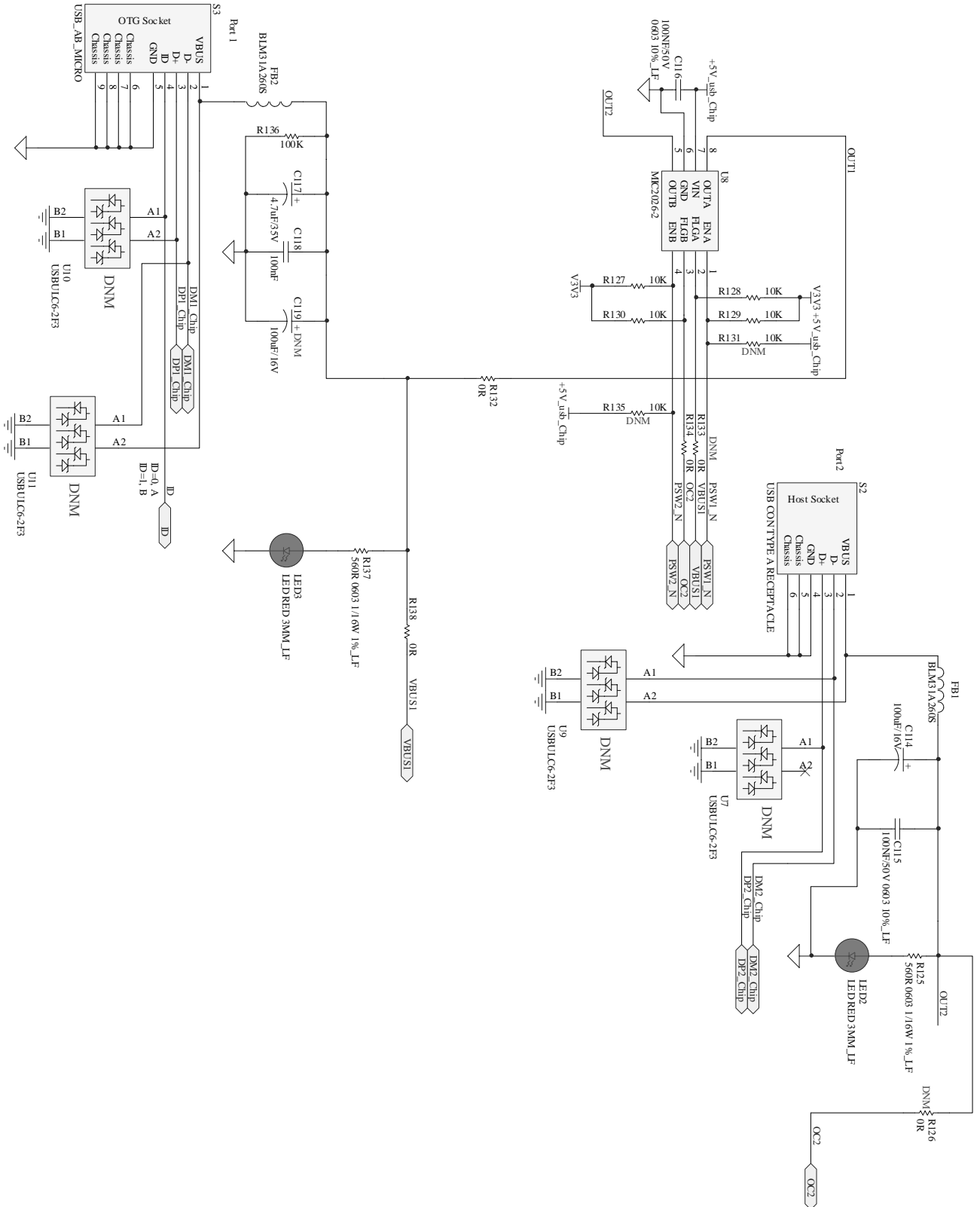

Figure 15 USB ports

UM0865

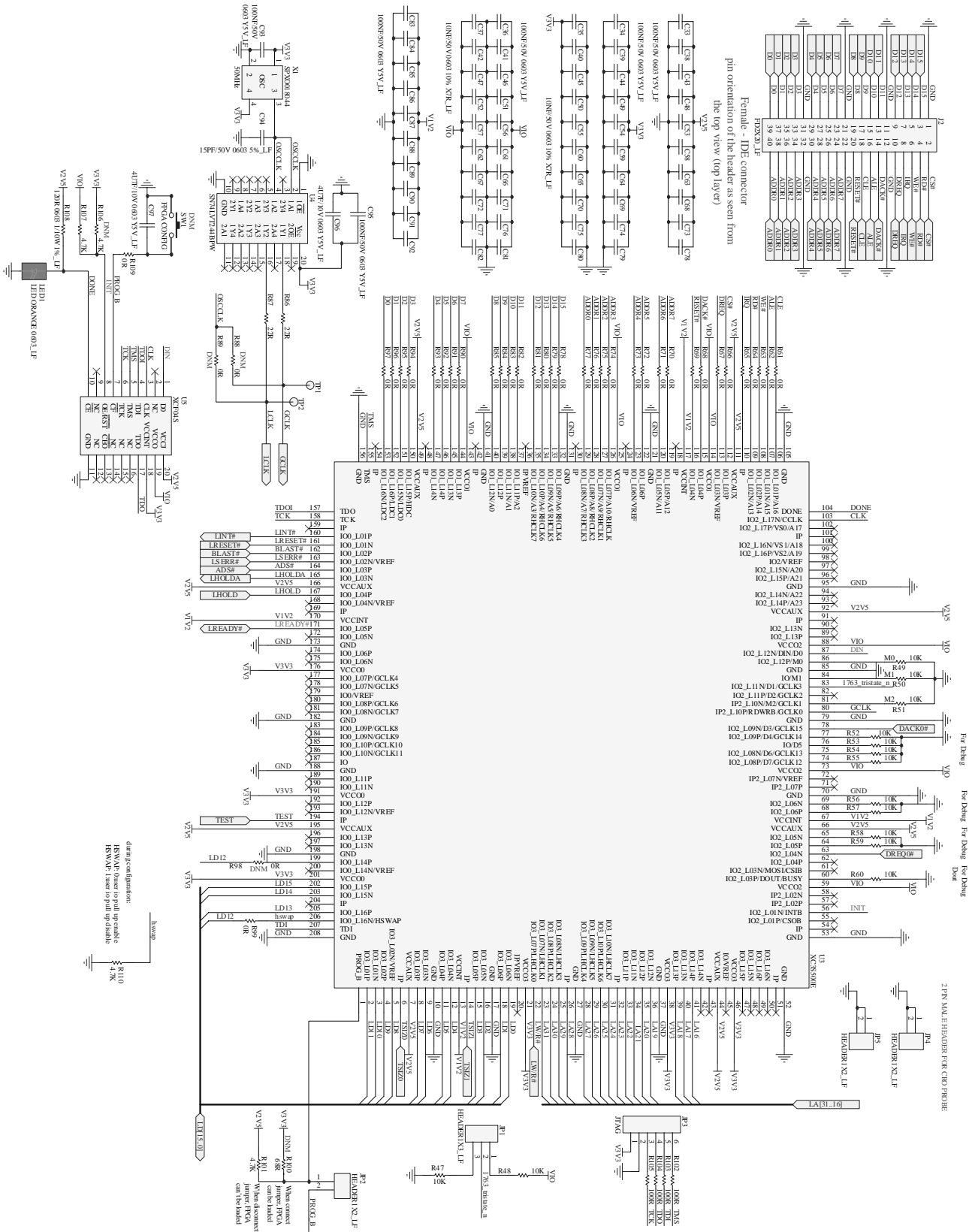

Figure 16 FPGA

UM0865

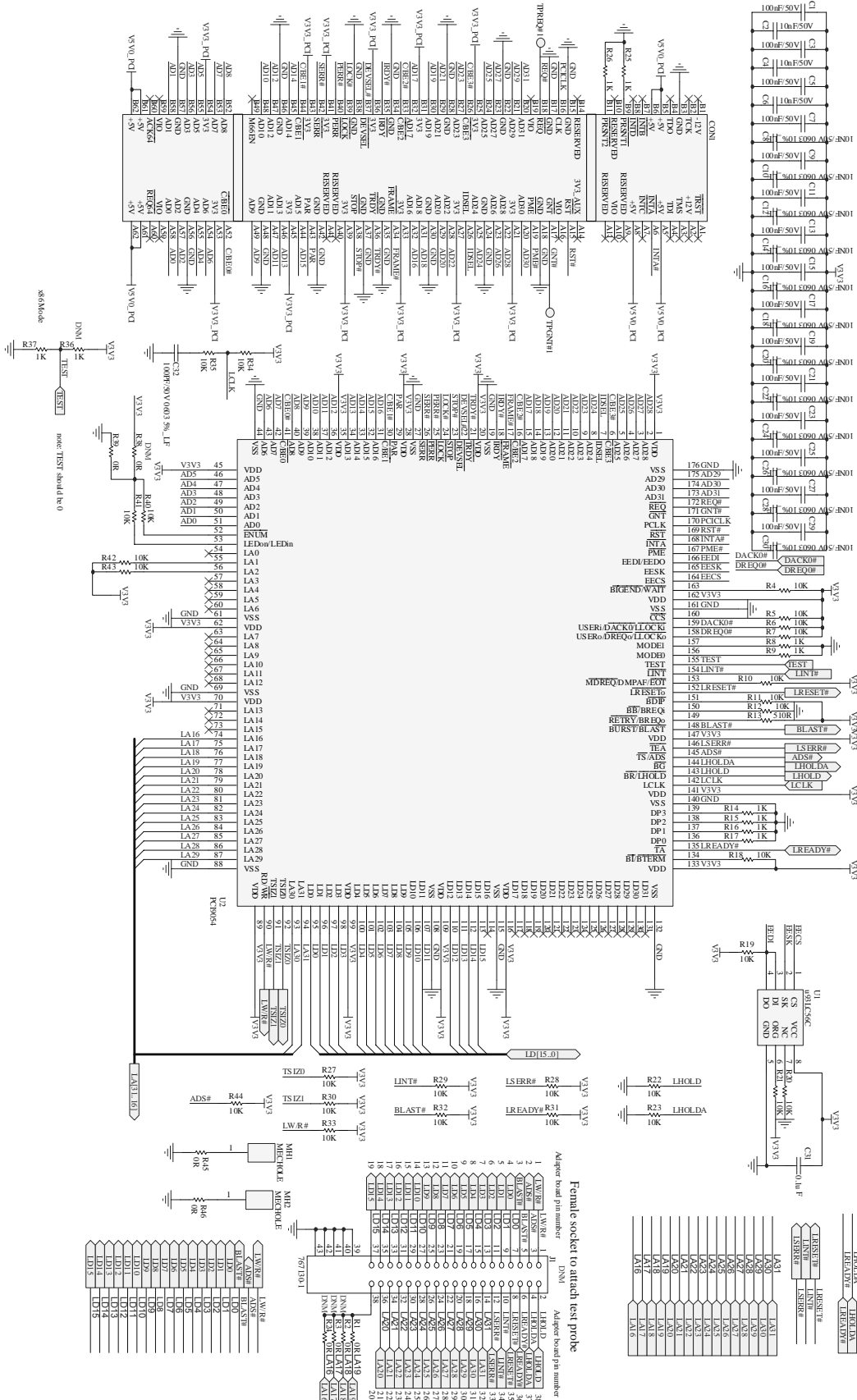

Figure 17 PCI

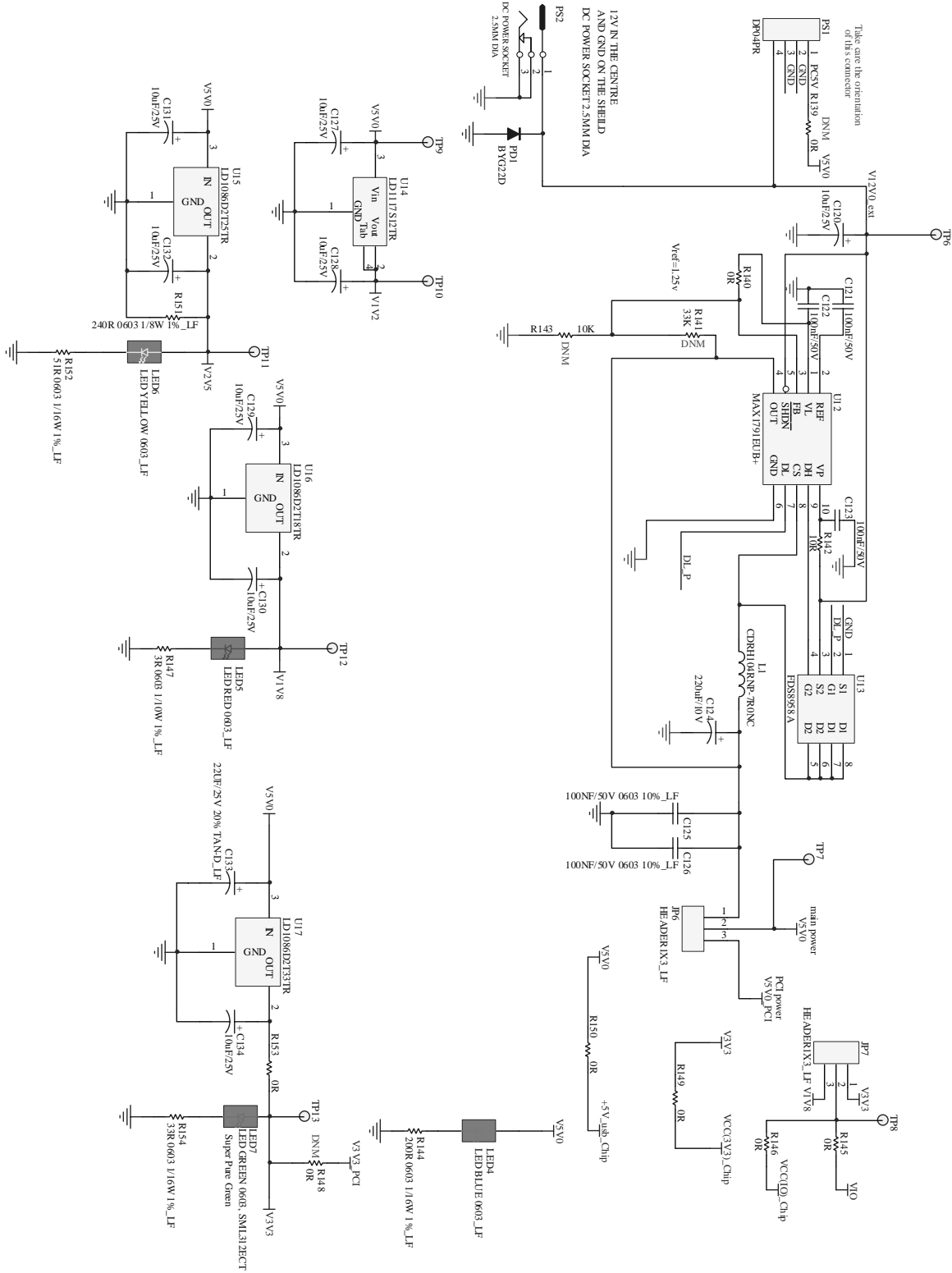

Figure 18 Power

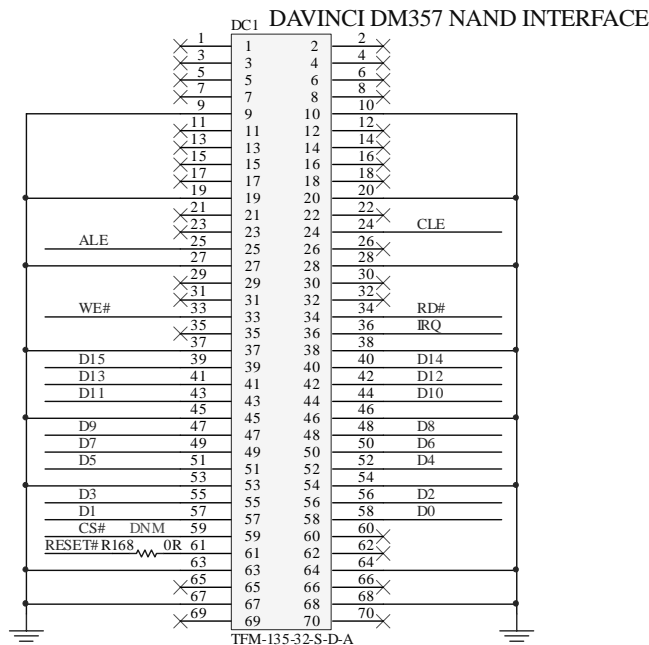
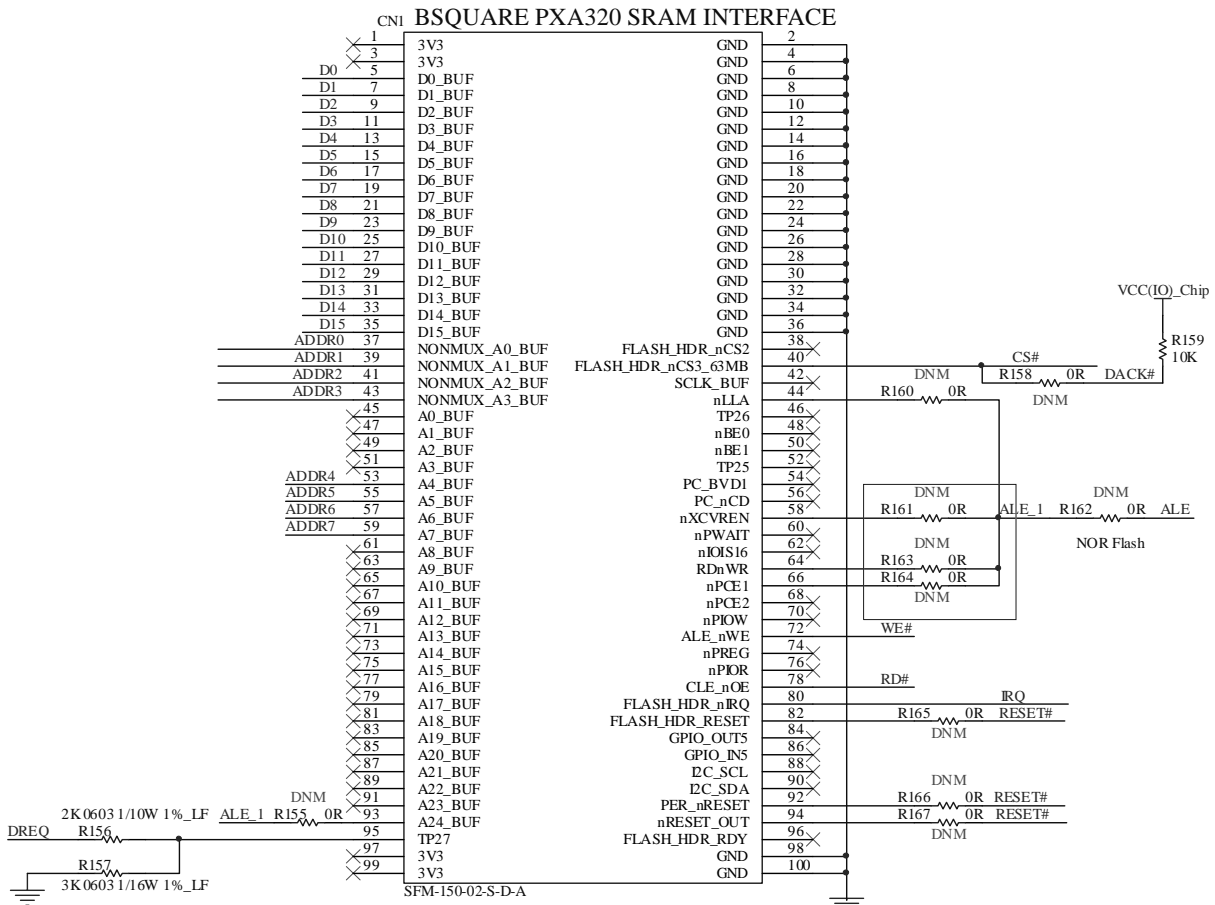

Figure 19 Connectors

5 List of materials

Table 7 List of materials

Part type	Designator	Footprint	Description
0 Ω	R80, R81, R83, R82, R77, R76, R79, R78, R93, R92, R95, R94, R85, R84, R91, R90, R75, R64, R63, R66, R65, R39, R38, R62, R61, R72, R71, R74, R73, R68, R67, R70, R69, R155, R148, R162, R158, R149, R146, R153, R150, R167, R166, R160, R168, R164, R161, R165, R163, R145, R89, R88, R123, R109, R97, R96, R98, R99, R138, R126, R140, R139, R133, R124, R132, R134, R3, R2, R1, R45, R46, R24	R0603	Resistor SMD 0603 1/16W 1% 0 Ω , lead free
1 k Ω	R25, R37, R26, R9, R8, R14, R15, R16, R36, R17	R0603	Resistor SMD 0603 1/10W 1% 1 k Ω lead free
2 k Ω	R156	R0603	Resistor SMD 0603 1/10W 1% 2 k Ω , lead free
3 k Ω	R157	R0603	Resistor SMD 0603 1/16W 1% 3 k Ω , lead free
3 Ω	R147	R0603	Resistor SMD 0603 1/10W 1% 3 Ω , lead free
4.7 k Ω	R107, R110, R106, R101	R0603	Resistor SMD 0603 1/10W 1% 4K7 lead free
4.7 μ F	C108, C112	TAN SMD-A	Capacitor tan SMD-A 4u7F/10 V +/-20%, lead free
4.7 μ F	C96, C97	C0603	Capacitor SMD 0603 4u7F/10 V Y5V +80%-20%, lead free
4.7 μ F	C117	ELE SMD-B	Capacitor Ele SMD-B 4u7F/35 V +/-20%, lead free
10 k Ω	R59, R60, R57, R56, R58, R43, R118, R44, R130, R49, R47, R117, R55, R111, R42, R121, R113, R50, R114, R112, R52, R53, R54, R51, R119, R122, R120, R6, R7, R143, R5, R12, R135, R10, R11, R41, R40, R34, R35, R159, R48, R4, R22, R32, R27, R28, R29, R131, R33, R127, R30, R18, R19, R129, R128, R23, R31, R20, R21	C0603	Resistor SMD 0603 1/16W 1% 10 k Ω lead free
10 nF	C80, C75, C70, C104, C42, C37, C65, C45, C40, C35, C60, C55, C50, C102, C82, C77, C72, C106, C98, C100, C52, C47, C57, C67, C62, C24, C12, C14, C26, C10, C30, C28, C8, C4, C2, C22, C20, C6, C16, C18	C0603	Capacitor SMD 0603 10 nF/50 V 10% X7R

Part type	Designator	Footprint	Description
10 Ω	R147	C0603	Resistor SMD 0603 1/16W 1% 10 Ω , lead free
10 μ F	C128, C130, C120, C127, C129, C134, C132, C131	ELE SMD-B	Capacitor Ele SMD-B 10uF/25 V +/-20%, lead free
12 k Ω	R115, R116	C0603	Resistor SMD 0603 1/16W 1% 12 k Ω , lead free
15 pF	C94	C0603	Capacitor SMD 0603 15 pF/50 V 5%, lead free
18 pF	C110, C111	C0603	Capacitor SMD 0603 18 pF / 50 V 5%
22 Ω	R86, R87	C0603	Resistor SMD 0603 1/16W 1% 22 Ω , lead free
22 μ F	C133	TAN SMD-D	Capacitor tan SMD-D 22 μ F/25 V +/-20%, lead free
33 k Ω	R141	C0603	Resistor SMD 0603 1/16W 1% 33 k Ω , lead free
33 Ω	R154	C0603	Resistor SMD 0603 1/16W 1% 33 Ω lead free
51 Ω	R152	C0603	Resistor SMD 0603 1/16W 1% 51 Ω , lead free
68 Ω	R100	C0603	Resistor SMD 0603 1/16W 1% 68 Ω
100 k Ω	R136	C0603	Resistor SMD 0603 1/10W 1% 100 k Ω lead free
100 nF	C61, C23, C51, C21, C15, C56, C66, C49, C59, C76, C58, C71, C68, C63, C46, C19, C34, C44, C36, C64, C41, C39, C11, C73, C69, C74, C13, C78, C79, C33, C38, C5, C7, C48, C53, C9, C43, C17, C54, C25, C31, C29, C3, C1, C27, C95, C81, C87, C88, C83, C85, C86, C92, C84, C93, C89, C90, C91	C0603	Capacitor SMD 0603 100 nF/50 V +80-20%, lead free
100 nF	C126, C125, C121, C122, C115, C118, C101, C103, C107, C99, C105, C123, C116, C113, C109	C0603	Capacitor SMD 0603 100 nF/50 V 10%, lead free
100 pF	C32	C0603	Capacitor SMD 0603 100 pF/50 V 5% NPO
100 Ω	R103, R102, R105, R104	C0603	Resistor SMD 0603 1/10W 1% 100 Ω lead free
100 μ F	C114	ELE SMD-D	Capacitor Ele SMD-D 100 μ F/16 V 20%, lead free
120 Ω	R108	C0603	Resistor SMD 0603 1/10W 1% 120 Ω lead free
200 Ω	R144	C0603	Resistor SMD 0603 1/16W 1% 200 Ω , lead free
220 μ F	C124	ELE SMD-E	Capacitor Ele SMD 220 μ F/10 V FK series, low ESR, +/-20%, lead free

Part type	Designator	Footprint	Description
240 Ω	R151	C0603	Resistor SMD 0603 1/8W 1% 240 Ω, lead free
510 Ω	R13	C0603	Resistor SMD 0603 1/10W 1% 510 Ω lead free
560 Ω	R125, R137	C0603	Resistor SMD 0603 1/16W 1% 560 Ω, lead free
767130-1	J1	767130-1	Connector recept 38Pos 0.025CL 767130-1
B3S-1000	SW1	B3S-1000	Switch tact SMD 6 mm x 6 mm white
BLM31A260S	FB1, FB2	R1206	Murata ferrite bead, 1206 case, 0.05 Ω DC resistance
CDRH104RNP-7R0NC	L1	CDRH104RNP	Inductor SMD 7 μH/4.5 A DR1040-7R0-R
CS10 12.000MABJ-UT	X2	CS10	Crystal 12 MHz 6 x 3.5 mm CS10-12.000MABJ-UT
DC power socket 2.5 mm DIA	PS2	DC power socket	Socket DC jack 2.5 mm PCB Mt
DP04PR	PS1	DP04PR	Power disk drive RA 4-way
FD2X20_LF	J2	FD2X20	Connector PCB Mt 0.100" 2 x 20-way
FDS8958A	U13	SOIC-8_4 x 5 mm	Transistor FDS8958A NP SO-8
Header1 x 2_LF	JP2, JP4, JP5	Header1 x 2	Header pin 0.100" 1 x 2-way gold, lead free
Header1 x 3_LF	JP1, JP6, JP7	Header1 x 3	Header pin 0.100" 1 x 3-way gold, lead free
Header1 x 6_LF	JP3	Header1 x 6	Header pin 0.100" 1 x 6-way gold, lead free
Header2 x 8_LF	J3, J4, J5, J6	Header2 x 8	Header pin 0.100" 2 x 8-way gold, lead free
ISP1763 VFQFPN	U6	VFQFPN-64	-
LD1086D2T18TR	U16	D2PAK	IC reg LDO POS 1.8 V 1.5 A D2PAK
LD1086D2T25TR	U15	D2PAK	IC reg LDO POS 2.5 V 1.5 A D2PAK
LD1086D2T33TR	U17	D2PAK	IC reg LDO positive 3.3 V D2PAK
LD1117S12TR	U14	SOT-223	IC reg LDO POS 800MA 1.2 V SOT223
LED blue 0603_LF	LED4	LED0603	LED blue 0603
LED green 0603, SML312ECT	LED7	LED0603	Chip LED, green, SMD, 0603 package, 0.8 x 1.6 x 0.8 mm
LED orange 0603_LF	LED1	LED0603	LED orange 0603
LED red 3MM_LF	LED2, LED3	LED3mm	LED 3 mm red diffused
LED red 0603_LF	LED5	LED0603	LED red 0603

Part type	Designator	Footprint	Description
LED yellow 0603_LF	LED6	LED0603	LED yellow 0603
MAX1791EUB+	U12	MSOP-10_3 x 3 mm	IC MAX1791EUB+
MIC2026-2	U8	SOIC-8_4 x 5 mm	IC MIC2026-2YM
PCI9054	U2	F-QFP176/P.5N	-
SFM-150-02-S-D-A	CN1	SFM-150-02-S-D-A	Connector SMT 0.5" 2x50 SFM-150-02-S-D-A
SMB PCB VERT	S1	SMB	SMB jack 50 Ω PCB Mt ST
SN74LVT244BPW	U4	TSSOP20_4.4 x 6.5 mm	IC 74LVT244BPW 20-TSSOP
SPX0018044	X1	SPX0018044	Oscillator 50.000 MHz HCMOS 3.3 V 1/2 size
Test point 1.8	TPREQ#1, TPGNT#1, TP11, TP12, TP13, TP10, TP7, TP6, TP9, TP4, TP1, TP2, TP3, TP8, TP5	TP18	Test point
TFM-135-32-S-D-A	DC1	TFM-135-32-S-D-A	Samtec connector SMT, vertical, plug, 35 x 2, TFM- 135-32-S-D-A
USB con type A receptacle	S2	USB_A	USB type A RA 4-way 87520- 0010B
USBULC6-2F3	U7, U9, U10, U11	USBULC6-2F3	ESD protection diode
USB_AB_MICRO	S3	USB micro type AB	Micro USB type AB SMD R/A ZX62-AB-5P
XC3S500E	U3	PQ208	IC Spartan XC3S500E- 4PQG208C PQFP
XCF04S	U5	TSSOP20_4.4 x 6.5 mm	IC programmable XCF04SVOG20C 20-TSSOP
u93LC56C	U1	DIP8	IC 93LC56C-I/P, EEPROM DIP-8, lead free

Glossary

EEPROM	Electrically Erasable Programmable Read-Only Memory
FPGA	Field-Programmable Gate Array
NAND	Not AND
NOR	Nor OR
OS	Operating System
OTG	On-The-Go
PCI	Peripheral Component Interconnect
PIO	Parallel Input/Output
RAM	Random-Access Memory
SRAM	Static Random Access Memory
USB	Universal Serial Bus